

markilux by Aquarius Blinds

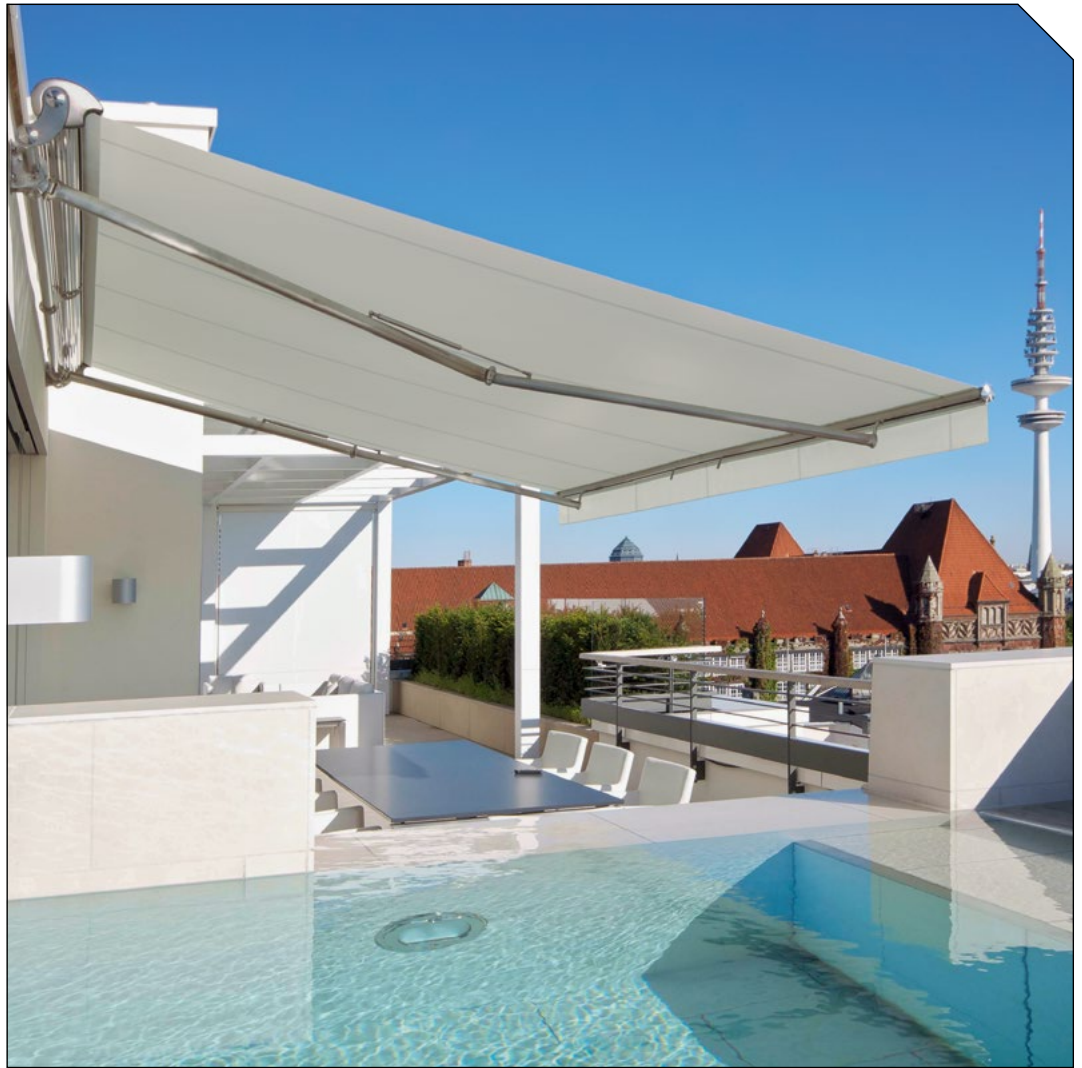

markilux ES-1

The designer awning made of stainless steel

**rated to wind resistance class 2
(corresponds to Beaufort 5)**

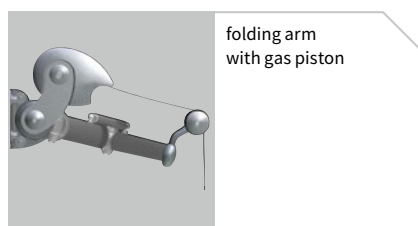
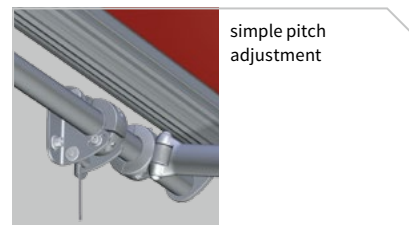
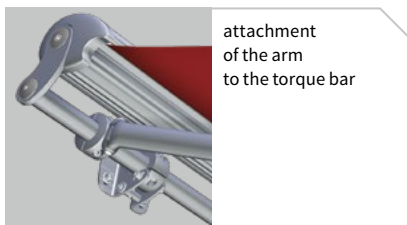
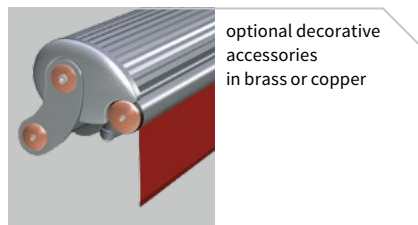
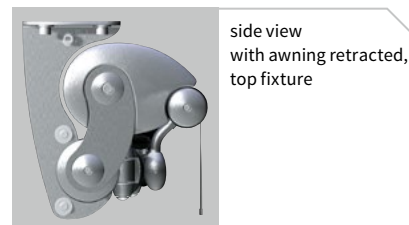
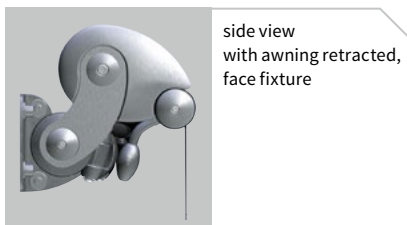
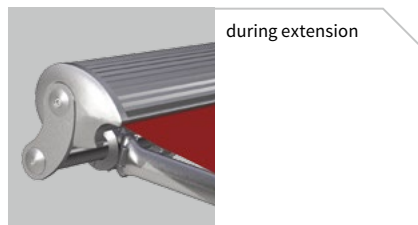

Design Features

the design has received numerous accolades:

- iF Product Design Award
- reddot design award

worldwide the only awning made completely of matt-brushed, marine grade stainless steel!

when retracted the cover is protected from the weather by the cassette, which encloses it completely

complete harmony of design, material and function

attractive brackets; design down to the last detail

the end caps made of solid brass or copper increase the uniqueness of this awning

Technical Specification

attractive ovoid folding arms with unique gas piston technology ensure a taut cover in every extended position

front profile, torque bar (50 mm Ø) and roller tube (95 mm Ø) are extremely resistant to deflection and twist

the 95 mm roller tube ensures the highest stiffness and the best possible cover winding characteristics even at the largest widths

the joint components of the folding arms are made of high tensile strength, drop-forged stainless steel; the pivot bolts sit in Teflon-coated bronze bushes

Optional Accessories

an easily installed light and wind sensor provides intelligent control and essential protection

Dimensions and configuration options

	M									M min.	
	250	300	350	400	450	500 ¹⁾	550	600	650	433	
	236	251	301	351	401	451	501	551	601	601	
	250	300	350	400	450	500	550	600	650	650	
H	200	2)									236
	250	-	2)								286
	300	-	-	2)							336
	350	-	-	-	2)						386

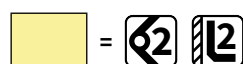

a rolltex bearing with accompanying bracket is always placed under a central seam

single unit,
dimensions in cm

1) in the case of face and top fixture: 2 brackets + 1 coverboard support with bracket;

in the case of eaves fixture: 3 eaves fixture brackets.

2) please note the minimum widths!

Operation / Drive

	standard	optional
radio-controlled motor (433 MHz)	<input checked="" type="checkbox"/>	-
io radio controls	-	<input checked="" type="checkbox"/>
hard-wired motor	-	<input checked="" type="checkbox"/>

Dimensions and tolerances

	width	projection
housing tolerance	+0 / -20 mm	±40 mm
awning cover width = awning width	-110 mm	
awning cover length = awning projection		+200 mm

Covers

	fabric range no.	standard	optional
sunsilk snc	324 .. / 328 .. / 369 ..	<input checked="" type="checkbox"/>	-
sunsilk perla FR	374 ..	-	<input checked="" type="checkbox"/>
sunvas snc	310 .. / 311 .. / 313 .. - 315 ..	<input checked="" type="checkbox"/>	-
sunvas perla	370 ..	-	<input checked="" type="checkbox"/>

Frame colours

	standard	optional
marine grade stainless steel		-

The width of the awning cover is always **less** than that of the awning. Pitch adjustment range: from 0° to 30° (to the horizontal).

Definition of projection: Please consult the section "Technical Information".

It takes approximately **12 seconds per metre** to extend the awning in the case of **motor-driven units**.

This model is only available as a single unit.

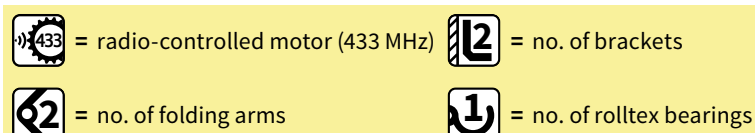

M = awning width
M min. = minimum widths
H = projection

Fixtures, fittings and accessories

Fixture brackets

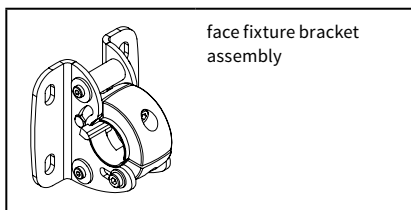

face fixture bracket assembly

744341

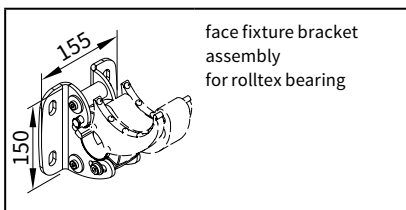

face fixture bracket assembly for rolltex bearing

746761

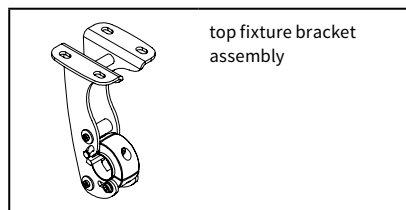

top fixture bracket assembly

745791

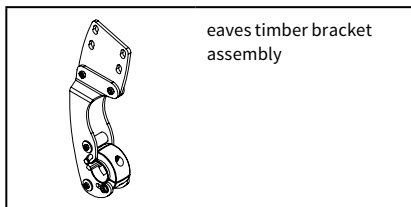

eaves timber bracket assembly

745851

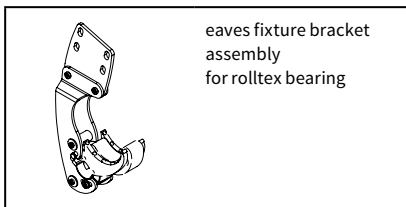

eaves fixture bracket assembly for rolltex bearing

746781

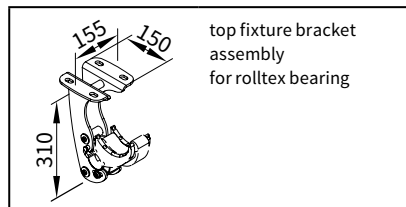

top fixture bracket assembly for rolltex bearing

746771

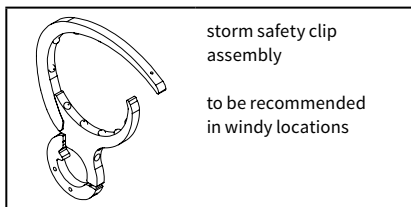

storm safety clip assembly
to be recommended in windy locations

725461

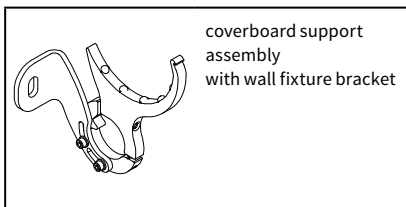

coverboard support assembly with wall fixture bracket

746331

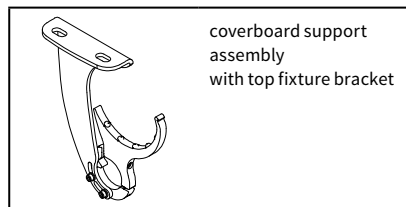

coverboard support assembly with top fixture bracket

746341

Accessories

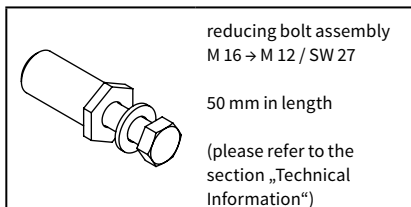

reducing bolt assembly M 16 → M 12 / SW 27
50 mm in length
(please refer to the section „Technical Information“)

753891

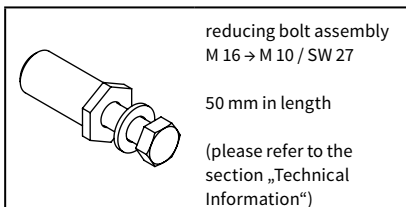

reducing bolt assembly M 16 → M 10 / SW 27
50 mm in length
(please refer to the section „Technical Information“)

754921

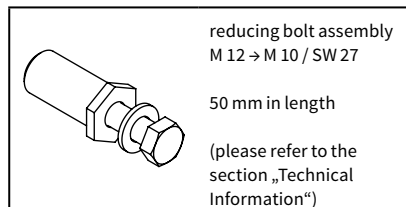

reducing bolt assembly M 12 → M 10 / SW 27
50 mm in length
(please refer to the section „Technical Information“)

754911

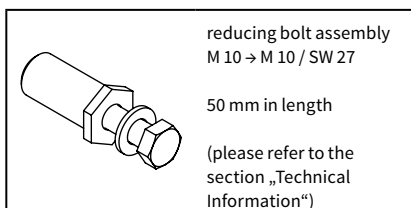

reducing bolt assembly M 10 → M 10 / SW 27
50 mm in length
(please refer to the section „Technical Information“)

754901

Face fixture

Pull-out force [N=Newton] per upper fixing point according to EN 13561, wind resistance class 2

compression-proof substrate										non compression-proof substrate										
M [cm]										M [cm]										
250 300 350 400 450 500 550 600 650										250 300 350 400 450 500 550 600 650										
H [cm]	FB [N]									FB [N]										
200	984	1108	1748	1355	1479	1603	1726	1850	1973	1203	1354	1505	1656	1808	1959	2110	2261	2412		
250	—	1572	2329	1925	2102	2278	2455	2631	3125	—	1921	2137	2353	2569	2784	3000	3216	3820		
300	—	—	3027	2567	2805	3044	3668	3942	4216	—	—	2846	3138	3429	3720	4483	4818	5153		
350	—	—	—	3336	3645	4430	4788	5145	—	—	—	4077	4454	5415	5852	6289	—	—		
HT BHT	2 155 mm					3 155 mm					2 155 mm					3 155 mm				
BM	8					12					8					12				

The pull-out force refers to the vertical centre to centre measurement between the fixture points of **90 mm**. If this measurement is reduced to the minimum, the pull-out force increases by up to **14%** in the case of **compression-proof** substrates and by up to **19%** in the case of **non compression-proof** substrates.

If the awning is fixed with 2 brackets per folding arm, the pull-out force can be halved.

Place the brackets immediately to the left and right of the arm bearer.

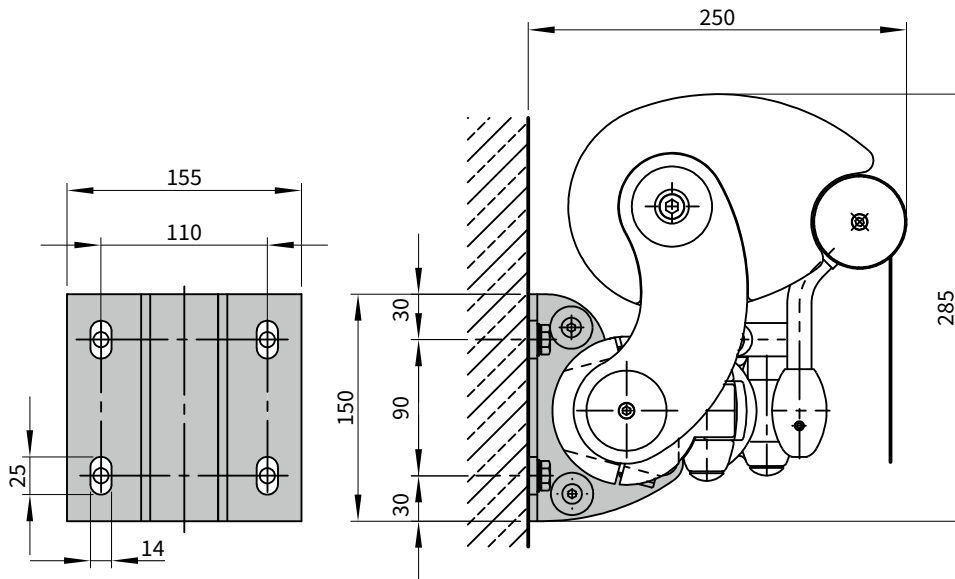

- M = awning width
- H = projection
- FB = pull-out force per fixing point
- HT | BHT = bracket quantity | width
- BM = no. of fixing points

dimensions in mm

Top fixture

Pull-out force [N=Newton] per upper fixing point according to EN 13561, wind resistance class 2

		compression-proof substrate									non compression-proof substrate								
		M [cm]									M [cm]								
		250	300	350	400	450	500	550	600	650	250	300	350	400	450	500	550	600	650
H [cm]	FB [N]																		
200		1047	1183	1319	1455	1591	1728	1864	2000	2136	1266	1429	1593	1756	1920	2084	2247	2411	2574
250		—	1647	1836	2025	2214	2403	2592	2781	3288	—	1996	2224	2453	2681	2909	3138	3366	3983
300		—	—	2416	2667	2918	3169	3806	4092	4379	—	—	2934	3238	3541	3845	4621	4968	5316
350		—	—	—	3436	3757	4555	4925	5295	—	—	—	—	4177	4567	5540	5989	6439	—
HT BHT		2 155 mm				3 155 mm					2 155 mm				3 155 mm				
BM		8				12					8				12				

The pull-out force refers to the vertical centre to centre measurement between the fixture points of **90 mm**. If this measurement is reduced to the minimum, the pull-out force can increase by up to **14%**. If the awning is installed with two brackets per folding arm, the pull-out force can be reduced by half. Place the brackets immediately to the left and right of the arm bearer.

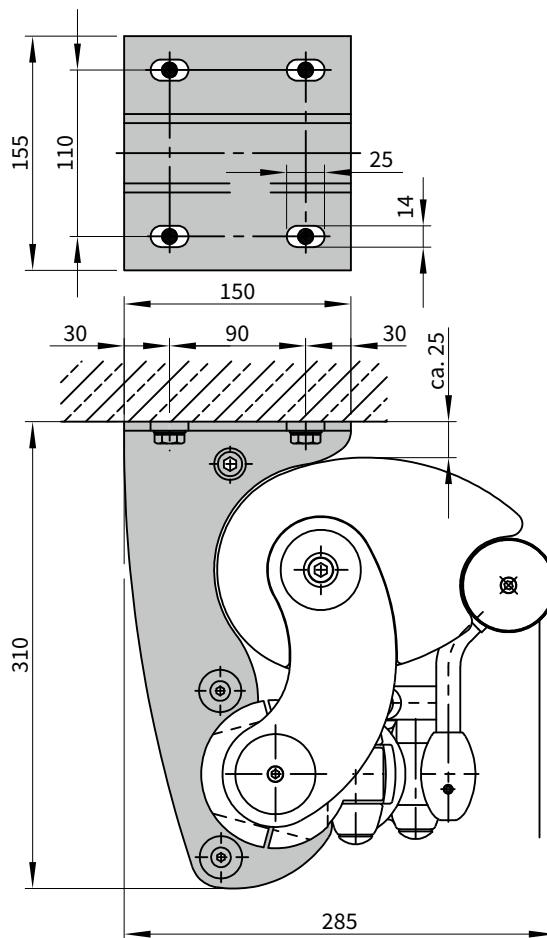

- M = awning width
- H = projection
- FB = pull-out force per fixing point
- HT | BHT = bracket quantity | width
- BM = no. of fixing points

dimensions in mm

Eaves fixture

Torque [Nm = Newton metres] for the fixture bracket next to the arm, shear force [N = Newton] per fixing point according to EN 13561, wind resistance class 2

H [cm]	Torque M [cm]									Shear force M [cm]								
	250	300	350	400	450	500	550	600	650	250	300	350	400	450	500	550	600	650
	Md [N]									FS [N]								
200	217	244	271	298	325	353	380	407	434	2531	2858	3186	3513	3840	4167	4495	4822	5149
250	—	346	385	423	462	501	540	579	688	—	3992	4449	4906	5362	5819	6275	6732	7965
300	—	—	512	565	617	670	807	867	928	—	—	5868	6475	7083	7690	9241	9936	10631
350	—	—	—	734	802	975	1053	1132	—	—	—	—	8354	9134	11080	11979	12878	—
HT	2				3					2				3				
BM	8				12					8				12				

The shear force is calculated on the basis of 2 fixing points per bracket, because – depending on the roof pitch – it cannot be guaranteed that 4 fixing points per bracket can be used.

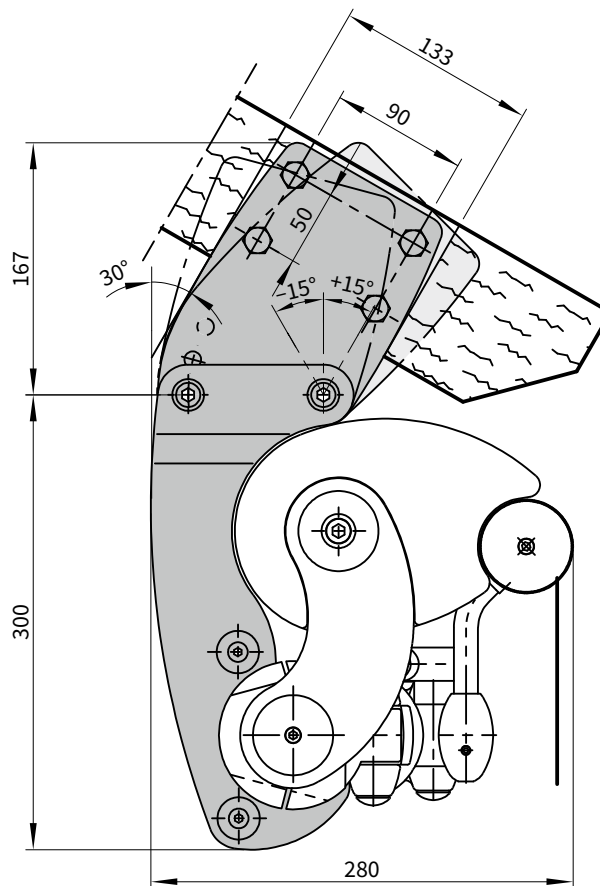

- M = awning width
- H = projection
- Md = torque value for the bracket in the immediate vicinity of the arm
- FS = shear force
- HT = no. of brackets
- BM = no. of fixing points

dimensions in mm

Dimensions at different awning pitches

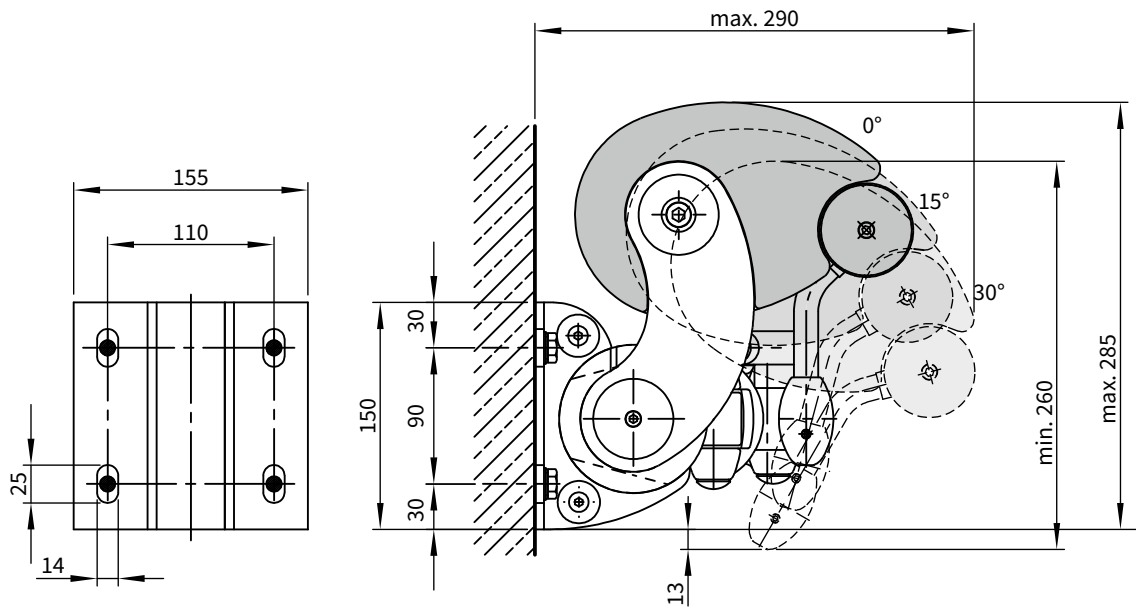

dimensions in mm

Bracket range for awnings with 2 folding arms

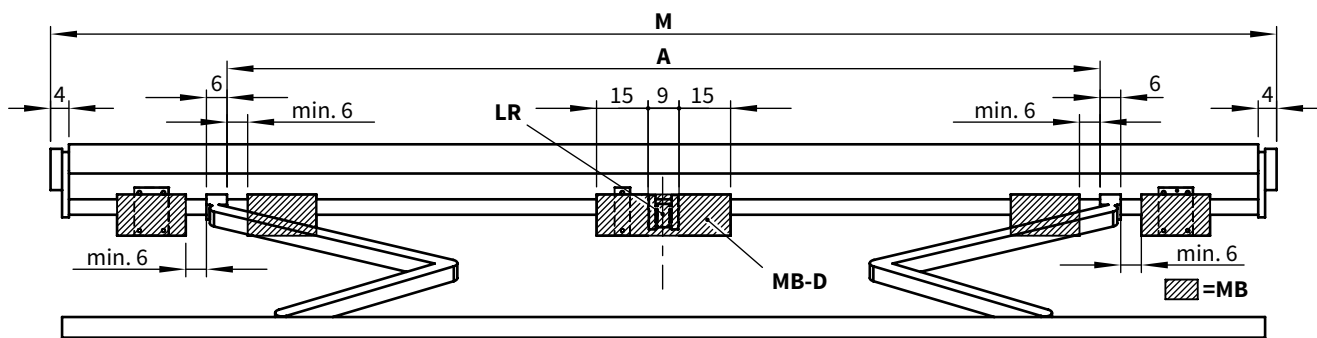

dimensions in cm

M [cm]	SB →	250	300	350	400	450	500	550	600	650
	ZB →	236–250	251–300	301–350	351–400	401–450	451–500	501–550	551–600	601–650

H [cm] ↓	A [cm]								
200	214*	229	262	292	332	372	407	442	472
250	-	264*	279	292	332	372	407	442	472
300	-	-	314*	329	332	372	407	442	472
350	-	-	-	364*	379	387	407	442	-

dimensions in cm

	BHT ↓	HT ↓	
W	155 mm	2	3
DE	155 mm	2	3
DA	90 mm	2	3

* = please note the minimum widths! In the case of small awnings the brackets can only be fitted inside the arms, i.e. the position denoted by measurement A.

M = awning width

H = projection

A = arm position

HT = no. of brackets

BHT = bracket width

MB = bracket fixture range

W = face fixture

DA = eaves fixture

DE = top fixture

SB = standard width

ZB = intermediate width

MB-D = range within which the coverboard support should be fitted (depends on the awning size)

LR = a rolltex bearing with accompanying bracket is always placed under a central seam (depends on the awning size)

If the brackets cannot be positioned in accordance with this table, make sure the actual measurements are noted on the order form!